

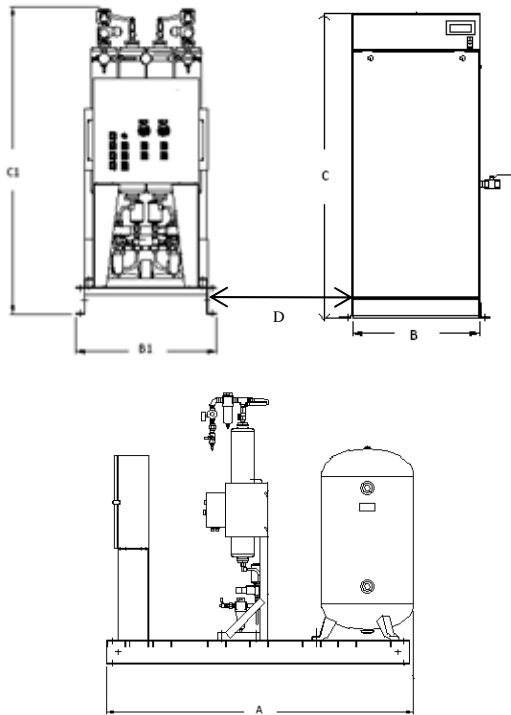

Medical Scroll Enclosure Duplex

Rev. 7/11/13

DIMENSIONS								
MODEL	DIM. A	DIM. B	DIM. B1	DIM. C	DIM. C1	DIM. D	Inlet	Outlet
MSED1003	80"	26"	32"	61"	70"	24"	1"	3/4"
MSED1504	80"	26"	32"	61"	78"	24"	1 1/2"	3/4"
MSED2004	80"	26"	32"	61"	78"	24"	1 1/2"	1"

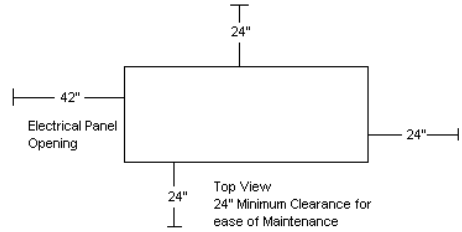

MINIMUM RECOMMENDED ELECTRICAL PANEL CLEARANCE PER OSHA

MINIMUM RECOMMENDED MAINTENANCE CLEARANCE

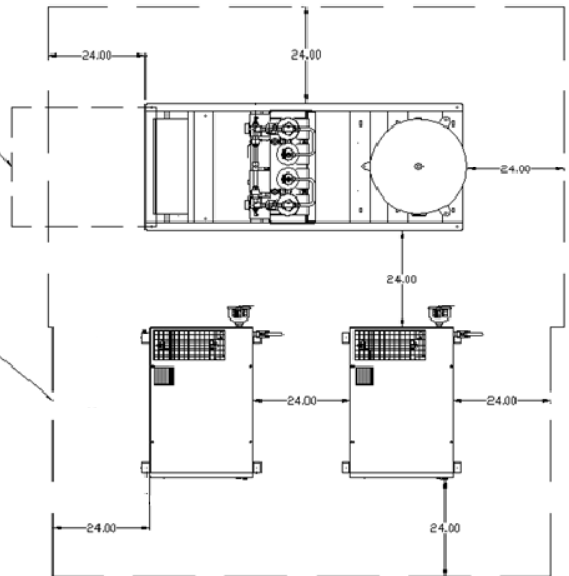

Medical Scroll Enclosure - Duplex										
MODEL	HP	ICFM @ 50 PSIG ^(1,6)	SCFM @ 50 PSIG ^(1,3)	TANK SIZE (Gal.)	BTU/HR ²	dB(A) ⁴ LEVEL	SYSTEM F.L.A.			SYSTEM WT (LBS)
							208V	230V	460V	
MSED1003	10 (2)	36.8	33.2	80	25,450	53	58.8	53.2	27.6	2,800
MSED1504	15 (2)	55.2	49.8	120	38,175	56	87.2	78.8	40.4	3,100
MSED2004	20 (2)	73.6	66.4	120	50,900	58	115.6	104.4	53.2	3,400

- Notes:
- 1- ICFM and SCFM values @ 50 PSIG are shown with one compressor in reserve per NFPA 99
 - 2 - BTU/HR Levels are shown with reserve compressor(s) on standby
 - 3 - Powerex recommends using performance ratings in SCFM (Standard Cubic Feet per Minute) when sizing Medical Air systems.
 - 4 - dB(A) is shown with one compressor in reserve per NFPA 99
 - 5 - 3 Year Limited Warranty
 - 6 - ICFM as standardly defined within the Medical Air Compressor Industry



Medical Scroll Enclosure Duplex 30-40 HP

Rev. 7/25/12

DIMENSIONS							
MODEL	DIM. A	DIM. B	DIM. B1	DIM. C	DIM. C1	Inlet	Outlet
MSED3006	99"	58"	32"	69"	96"	1 1/2"	1 1/2"
MSED4006	84"	58"	33"	69"	96"	1 1/2"	1 1/2"

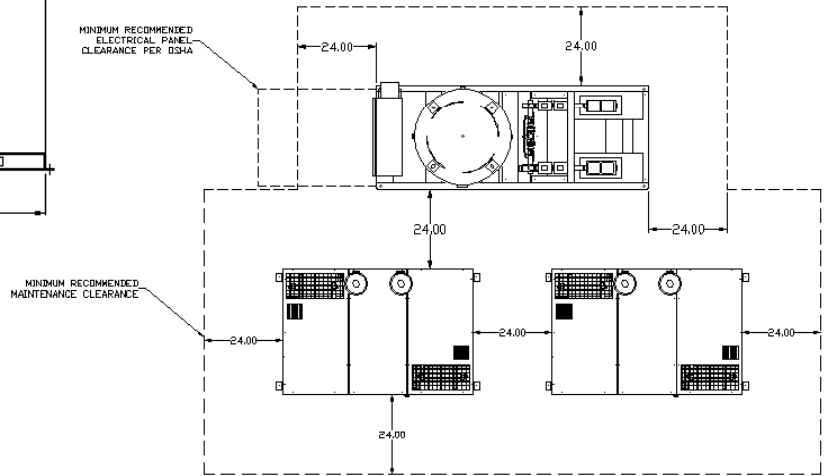
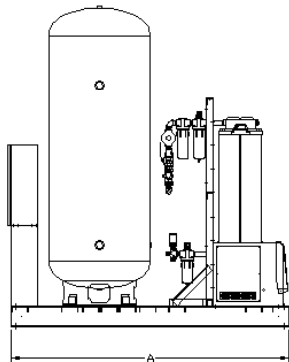
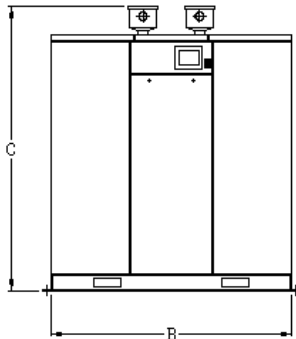
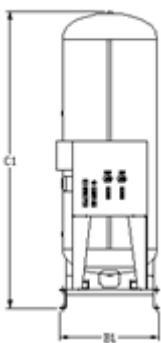
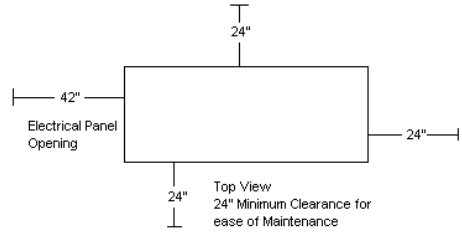

Medical Scroll Enclosure - Duplex										
MODEL	HP	ICFM @ 50 PSIG (1,6)	SCFM @ 50 PSIG (1,3)	TANK SIZE (Gal.)	BTU/HR ²	dB(A) ⁴ LEVEL	SYSTEM F.L.A.			SYSTEM WT. (LBS)
							208V	230V	460V	
MSED3006	30 (2)	110.4	99.6	240	76,350	59	172.4	155.6	78.8	5,100
MSED4006	40 (2)	147.2	132.8	240	101,800	60	229.2	206.8	104.4	5,500

- Notes:
- 1- ICFM and SCFM values @ 50 PSIG are shown with one compressor in reserve per NFPA 99
 - 2- BTU/HR Levels are shown with reserve compressor(s) on standby
 - 3- Powerex recommends using performance ratings in SCFM (Standard Cubic Feet per Minute) when sizing Medical Air systems.
 - 4- dB(A) is shown with one compressor in reserve per NFPA 99
 - 5- 3 Year Limited Warranty
 - 6- ICFM as standardly defined within the Medical Air Compressor Industry



Medical Scroll Enclosure Triplex 10-20HP

Rev. 7/11/13

DIMENSIONS								
MODEL	DIM. A	DIM. B	DIM. B1	DIM. C	DIM. C1	DIM. D	Inlet	Outlet
MSET1004	80"	26"	32"	61"	78"	24"	1"	3/4"
MSET1505	99"	26"	32"	61"	84"	24"	1 1/2"	1 1/2"
MSET2006	84"	26"	32"	61"	84"	24"	1 1/2"	1 1/2"

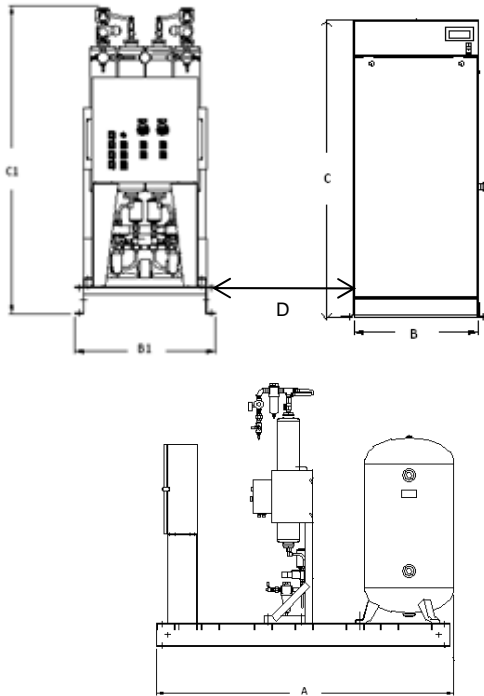
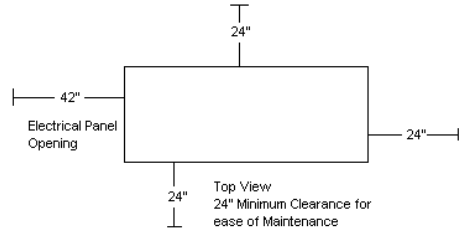

MINIMUM RECOMMENDED ELECTRICAL PANEL CLEARANCE PER OSHA

MINIMUM RECOMMENDED INTENANCE CLEARANCE

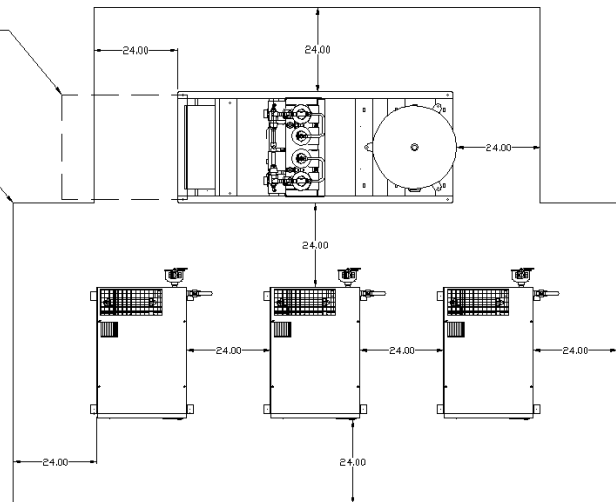

Scroll Enclosed Air Compressors										
Medical Scroll Enclosure - Triplex										
MODEL	HP	ICFM @ 50 PSIG (1,6)	SCFM @ 50 PSIG (1,3)	TANK SIZE (Gal.)	BTU/HR ²	dB(A) ⁴ LEVEL	SYSTEM FLA			SYSTEM WT. (LBS)
							208V	230V	460V	
MSET1004	10 (3)	73.6	66.4	120	50,900	56	87.2	78.8	40.4	3,700
MSET1505	15 (3)	110.4	99.6	200	76,350	59	129.8	117.2	59.6	4,850
MSET2006	20 (3)	147.2	132.8	240	101,800	61	172.4	155.6	78.8	4,900

- Notes:
- 1- ICFM and SCFM values @ 50 PSIG are shown with one compressor in reserve per NFPA 99
 - 2 - BTU/HR Levels are shown with reserve compressor(s) on standby
 - 3 - Powerex recommends using performance ratings in SCFM (Standard Cubic Feet per Minute) when sizing Medical Air systems.
 - 4 - dB(A) is shown with one compressor in reserve per NFPA 99
 - 5 - 3 Year Limited Warranty
 - 6 - ICFM as standardly defined within the Medical Air Compressor Industry



Medical Scroll Enclosure Triplex 30-40HP

Rev. 7/25/12

DIMENSIONS							
MODEL	DIM. A	DIM. B	DIM. B1	DIM. C	DIM. C1	Inlet	Outlet
MSET3006	84"	58"	33"	69"	96"	1 1/2"	2"
MSET4006	102"	58"	49"	69"	96"	1 1/2"	2"

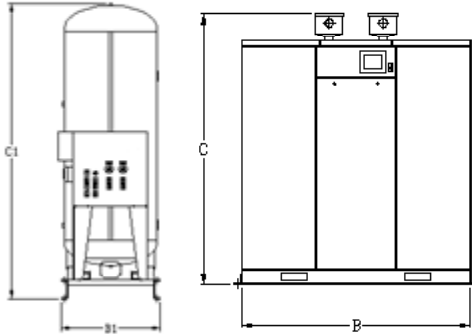
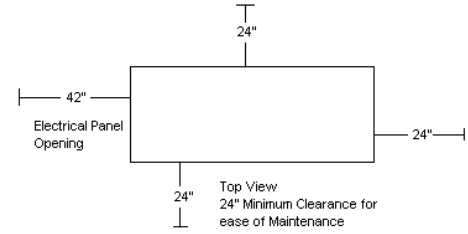

MINIMUM RECOMMENDED MAINTENANCE CLEARANCE

MINIMUM RECOMMENDED ELECTRICAL PANEL CLEARANCE PER OSHA

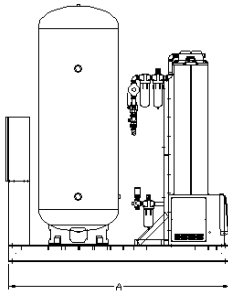
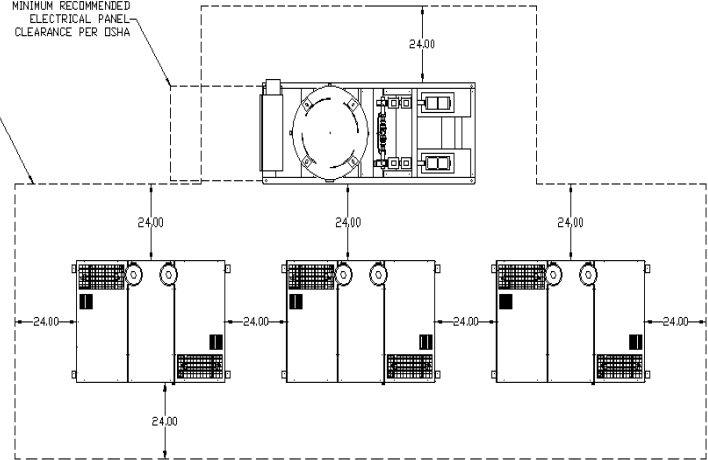

Scroll Enclosed Air Compressors										
Medical Scroll Enclosure - Triplex										
MODEL	HP	ICFM @ 50 PSIG (1,6)	SCFM @ 50 PSIG (1,3)	TANK SIZE (Gal.)	BTU/HR ²	dB(A) ⁴ LEVEL	SYSTEM F.L.A.			SYSTEM WT. (LBS)
							208V	230V	460V	
MSET3006	30 (3)	220.8	199.2	240	152,700	62	257.6	232.4	117.2	6,500
MSET4006	40 (3)	294.4	265.6	240	203,600	63	342.8	309.2	155.6	8,200

- Notes:
- 1 - ICFM and SCFM values @ 50 PSIG are shown with one compressor in reserve per NFPA 99
 - 2 - BTU/HR Levels are shown with reserve compressor(s) on standby
 - 3 - Powerex recommends using performance ratings in SCFM (Standard Cubic Feet per Minute) when sizing Medical Air systems.
 - 4 - dB(A) is shown with one compressor in reserve per NFPA 99
 - 5 - 3 Year Limited Warranty
 - 6 - ICFM as standardly defined within the Medical Air Compressor Industry



Medical Scroll Enclosure Quadplex

Rev. 7/25/12

DIMENSIONS								
MODEL	DIM. A	DIM. B	DIM. B1	DIM. C	DIM. C1	DIM. D	Inlet	Outlet
MSEQ1506	85"	26"	32"	61"	84"	24"	1 1/2"	1 1/2"
MSEQ2006	85"	26"	32"	61"	84"	24"	1 1/2"	2"

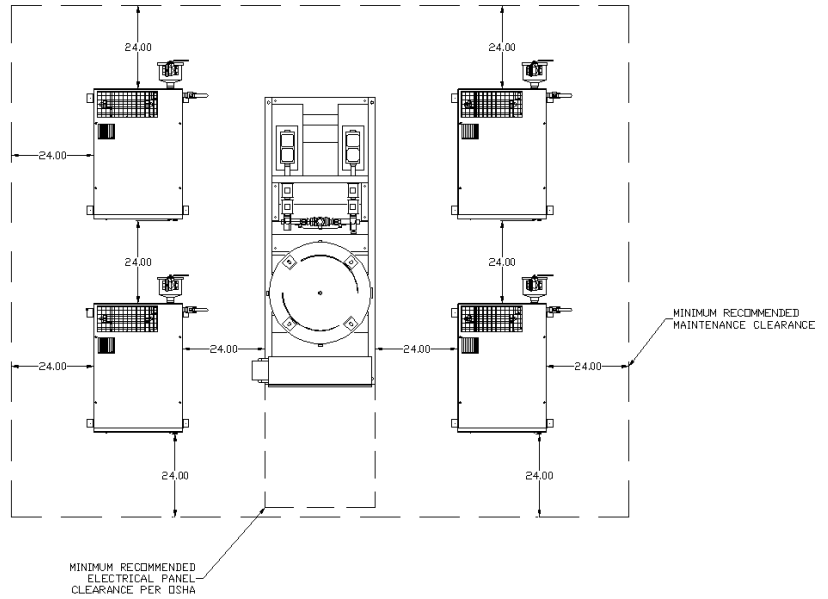
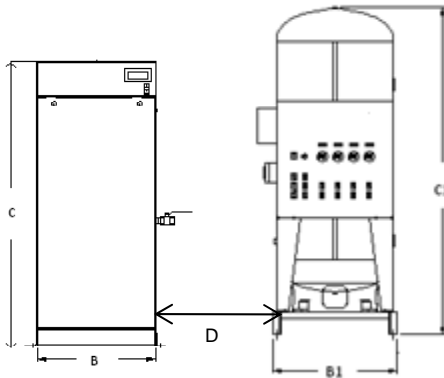
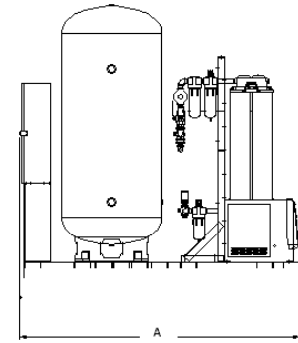
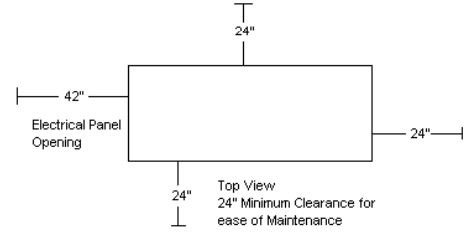

Scroll Enclosed Air Compressors										
Medical Scroll Enclosure - Quadplex										
MODEL	HP	ICFM @ 50 PSIG (1.6)	SCFM @ 50 PSIG (1.3)	TANK SIZE (Gal.)	BTU/HR ²	dB(A) ⁴ LEVEL	SYSTEM F.L.A.			SYSTEM WT. (LBS)
							208V	230V	460V	
MSEQ1506	15 (4)	165.6	149.4	240	114,525	61	172.4	155.6	78.8	5,050
MSEQ2006	20 (4)	220.8	199.2	240	152,700	63	229.2	206.8	104.4	6,150

- Notes:
- 1- ICFM and SCFM values @ 50 PSIG are shown with one compressor in reserve per NFPA 99
 - 2 - BTU/HR Levels are shown with reserve compressor(s) on standby
 - 3 - Powerex recommends using performance ratings in SCFM (Standard Cubic Feet per Minute) when sizing Medical Air systems.
 - 4 - dB(A) is shown with one compressor in reserve per NFPA 99
 - 5 - 3 Year Limited Warranty
 - 6 - ICFM as standardly defined within the Medical Air Compressor Industry



Medical Scroll Enclosure Quadplex

Rev. 7/25/12

DIMENSIONS								
MODEL	DIM. A	DIM. B	DIM. B1	DIM. C	DIM. C1	DIM. D	Inlet	Outlet
MSEQ3007	59"	58"	48"	69"	72"	24"	1 1/2"	2"
MSEQ4007	61"	58"	55"	69"	82"	24"	1 1/2"	2 1/2"

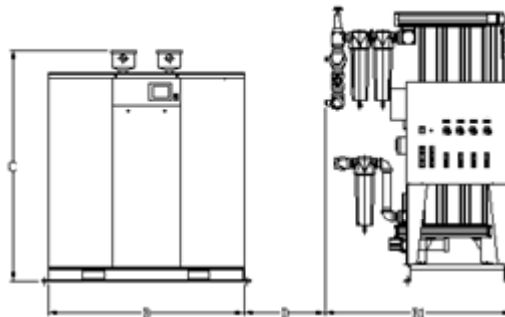
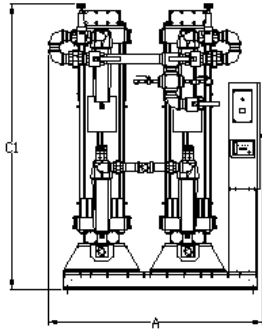
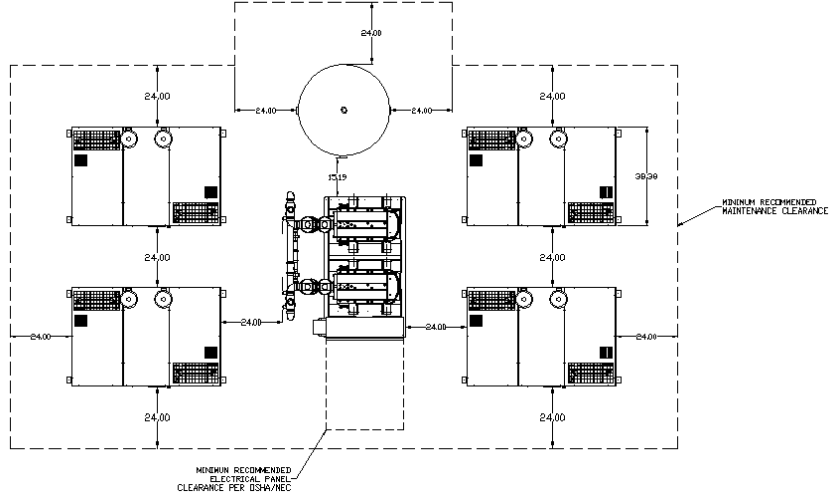
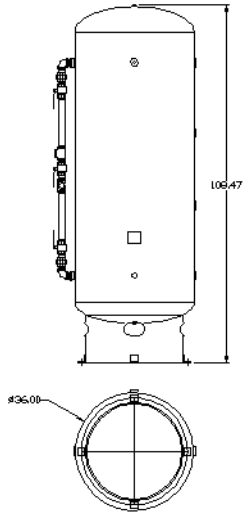
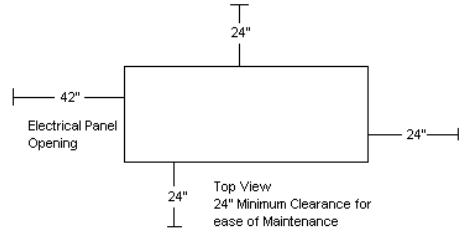

Scroll Enclosed Air Compressors										
Medical Scroll Enclosure - Quadplex										
MODEL	HP	ICFM @ 50 PSIG (1.6)	SCFM @ 50 PSIG (1.3)	TANK SIZE (Gal.)	BTU/HR ²	dB(A) ⁴ LEVEL	SYSTEM F.L.A.			SYSTEM WT. (LBS)
							208V	230V	460V	
MSEQ3007	30 (4)	331.2	298.8	400	229,050	64	342.8	309.2	155.6	8,730
MSEQ4007	40 (4)	441.6	398.4	400	305,400	65	456.4	411.6	206.8	10,550

- Notes:
- 1- ICFM and SCFM values @ 50 PSIG are shown with one compressor in reserve per NFPA 99
 - 2 - BTU/HR Levels are shown with reserve compressor(s) on standby
 - 3 - Powerex recommends using performance ratings in SCFM (Standard Cubic Feet per Minute) when sizing Medical Air systems.
 - 4 - dB(A) is shown with one compressor in reserve per NFPA 99
 - 5 - 3 Year Limited Warranty
 - 6 - ICFM as standardly defined within the Medical Air Compressor Industry